

TM 11-5820-357-10

DEPARTMENT OF THE ARMY TECHNICAL MANUAL

OPERATOR'S MANUAL

RADIO RECEIVER R-390/URR



*HEADQUARTERS DEPARTMENT OF THE ARMY
29 DECEMBER 1960*

DEPARTMENT OF THE ARMY TECHNICAL MANUAL

OPERATOR'S MANUAL
RADIO RECEIVER R-390/URR

Headquarters, Department of the Army, Washington 25, D. C.
29 December 1960

WARNING**DANGEROUS VOLTAGES EXIST IN THIS EQUIPMENT**

Be careful when working on the 240-volt power supply and the circuits connected to it, or on the 115/230-volt ac line connections. Before connecting the receiver to an ac source, be sure that the chassis is connected to the same ground as the ac source.

DON'T TAKE CHANCES!

	Paragraph	Page
CHAPTER 1.	INTRODUCTION	
Section I.	General	
	Scope	1 3
	Forms and records	2 3
II.	Description and data	
	Purpose and use	3 3
	System application	4 3
	Technical characteristics	5 4
	Components of receiver	6 5
	Description	7 5
	Additional equipment required	8 5
CHAPTER 2.	OPERATING INSTRUCTIONS	
	General	9 7
	Controls and indicators	10 7
	Preparing receiver for reception	11 9
	Calibration procedure	12 9
	Voice signal reception	13 9
	Reception of cw and m cw signals	14 9
	Reception of frequency shift signals	15 9
	Reception of single-sideband signals	16 13
	Stopping procedure	17 13
	Antijamming procedure	18 19
CHAPTER 3.	MAINTENANCE INSTRUCTIONS	
	Scope of operator maintenance	19 25
	Preventive maintenance	20 25
	Visual inspection	21 25
	Checking fuses	22 25
	Operational checklist	23 25
CHAPTER 4.	DEMOLITION OF MATERIEL TO PREVENT ENEMY USE	
	Authority for demolition	24 27
	Methods of destruction	25 27
APPENDIX I.	REFERENCES	28
II.	BASIC ISSUE ITEMS LIST	29

*This manual supersedes TM 11-5820-357-10P, 4 November 1959, and such portions of TM 11-856, 11 January 1955, including C1, 23 June 1955, C2, 29 September 1955, C3, 19 January 1956, C4, 22 December 1958, and C5, 31 December 1959, as pertains to operation of equipment.

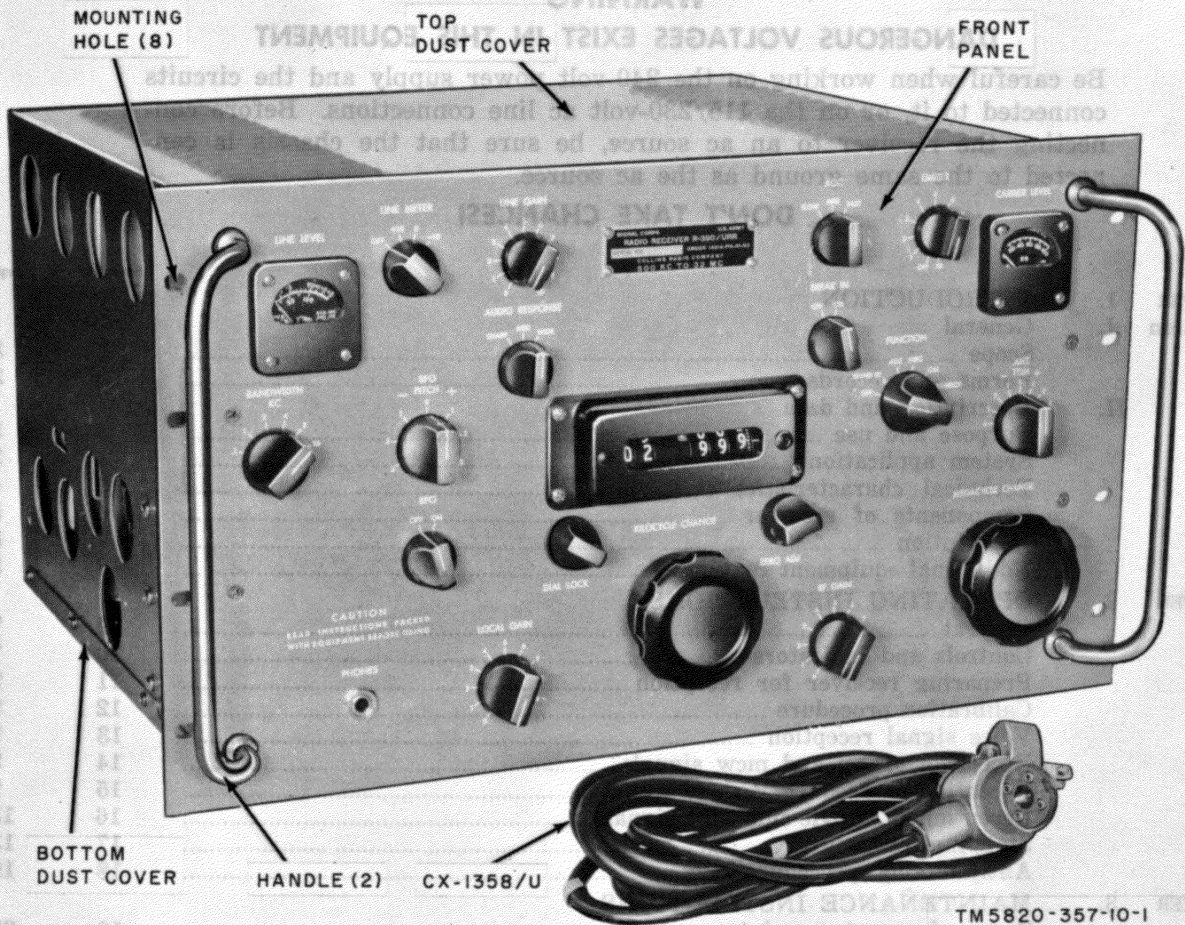

Figure 1. Radio Receiver R-390/URR.

CHAPTER 1

INTRODUCTION

Section I. GENERAL

1. Scope

This manual describes Radio Receiver R-390/URR (fig. 1) and covers its operation and operator's maintenance. It includes operation under usual conditions, methods of cleaning and inspecting the equipment, and replacement of parts available to first echelon maintenance. Throughout this manual, Radio Receiver R-390/URR will be referred to as the *receiver*.

2. Forms and Records

a. Unsatisfactory Equipment Reports.

- (1) Fill out and forward DA Form 468 (Unsatisfactory Equipment Report) to the Commanding Officer, U. S. Army Signal Materiel Support Agency, ATTN: SIGMS-ML, Fort Monmouth, N. J., as prescribed in AR 700-38.
- (2) Fill out and forward AF TO Form 29 (Unsatisfactory Report) to the Commander, Air Materiel Command, Wright-Patterson Air Force Base, Ohio, as prescribed in AR TO 00-35D-54.

b. *Report of Damaged or Improper Shipment.* Fill out and forward DD Form 6 (Report of Damaged or Improper Shipment) as prescribed in AR 700-58 (Army); Navy Shipping Guide, Article 1850-4 (Navy); and AFR 71-4 (Air Force).

c. *Preventive Maintenance Forms.* Prepare DA Form 11-238 (fig. 12), Maintenance Checklist for Signal Equipment (Sound Equipment, Radio, Direction Finding, Radar, Carrier, Radiosonde and Television), in accordance with instructions on the form.

d. *Parts List Form.* Forward DA Form 2028, Recommended Changes to DA Technical Manual Parts Lists or Supply Manual 7, 8, or 9, directly to the Commanding Officer, U. S. Army Signal Materiel Support Agency, ATTN: SIGMS-ML, Fort Monmouth, N. J., with comments on parts listing.

e. *Comments on Manual.* Forward all other comments on this publication directly to the Commanding Officer, U. S. Army Signal Materiel Support Agency, ATTN: PA2d, Fort Monmouth, N. J.

Section II. DESCRIPTION AND DATA

3. Purpose and Use

a. Radio Receiver R-390/URR is a general purpose receiver for use in fixed and mobile applications. The receiver provides for recep-

tion of continuous wave (cw), modulated-continuous-wave (mcw) amplitude-modulated (am.), frequency shift keyed (fsk), and single-sideband signals.

b. The receiver furnishes audiofrequency (af) output power to a local loudspeaker and headset or a balanced line. An intermediate frequency (if.) output is also provided so that received radio teletypewriter signals may be fed to other equipment for conversion into signals usable by teletypewriter equipment.

4. System Application

a. Space-Diversity Receiving System.

- (1) Two or three receivers can be connected as a space-diversity receiving system for reception of voice signals (fig. 2). This system provides sub-

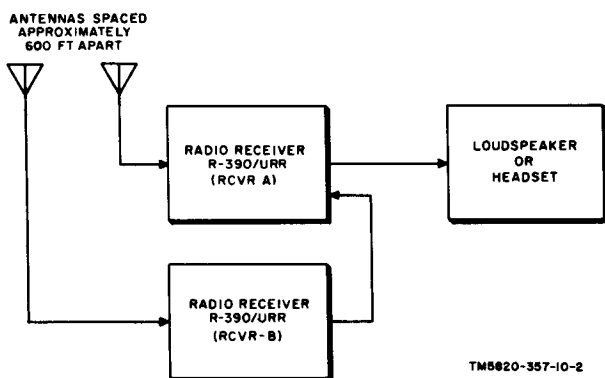
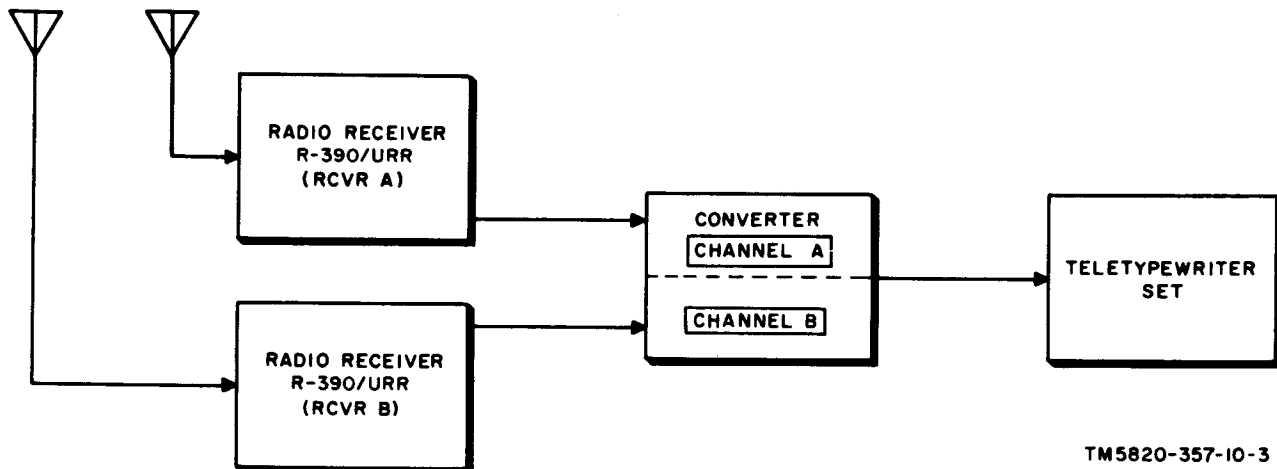

Figure 2. Space diversity receiving system.

ANTENNAS SPACED
APPROXIMATELY
600 FT APART



TM5820-357-10-3

Figure 3. Space-diversity radio teletypewriter system.

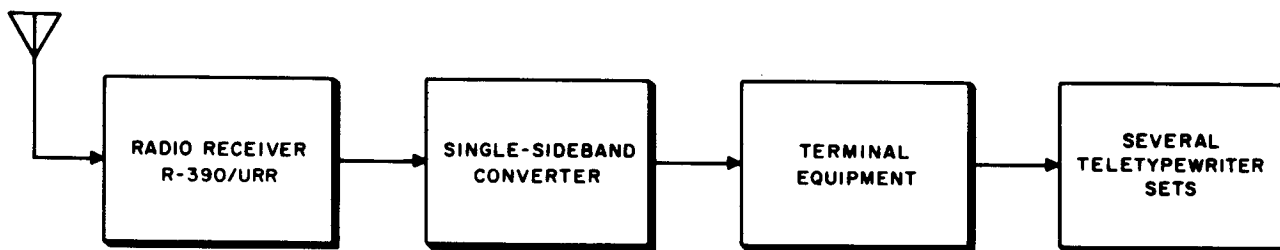

TM5820-357-10-4

Figure 4. Single-sideband radio teletypewriter system.

stantially uniform audio output to a loudspeaker or headset, minimizing the effect of fading signals.

- (2) Rhombic or doublet antennas spaced at least 600 feet apart are connected to the two receivers.

b. *Space-Diversity Radio Teletypewriter System.* Figure 3 shows two receivers connected in a space-diversity radio teletypewriter system. The doublet or rhombic antennas feed the incoming frequency-shift signals to the receivers. The outputs of the receivers are applied to a converter which provides diversity combining and produces direct current (dc) signals for the operation of teletypewriter equipment.

c. *Single-Sideband Radio Teletypewriter System.* A receiver and Single Sideband Converter CV-157/URR are connected as shown in figure 4 for the reception of single-sideband (ssb) multichannel radio teletypewriter sig-

nals occupying 12 kilocycles (kc) of radio-frequency (rf) spectrum space divided into two 6-kc sidebands, one 6-kc sideband on each side of a reduced carrier. A double-sideband signal, either am. or phase-modulated (pm), occupying up to a total of 12 kc of spectrum space also can be received. For additional information, refer to TM 11-649.

5. Technical Characteristics

Frequency range 0.5 to 32 mc in 32 bands.

Type of signals received A1 (cw), A2 (mcw), A3 (voice), F1 (frequency-shift keying), and A9 (composite transmissions such as multi-channel radio teletypewriter signals).

Type of tuning Continuous; frequency read directly on counter-type indicator.

Calibration points .. Every 100 kc.
 Power source 115/230 volts ac, 48-62 cps ($\pm 10\%$).
 Power input 270 watts total; 170 watts with oven heaters off.

Balanced 125-ohm nominal terminating impedance; matches 50- to 200-ohm balanced transmission lines or unbalanced lines, using adapters.

Antenna requirements:

Unbalanced Random length straight-wire or vehicular-mounted whip.

6. Components of receiver

a. Components. The components of Radio Receiver R-390/URR are listed in the following chart.

Quantity	Item	Height (in.)	Depth (in.)	Width (in.)	Unit weight (lb)
1	Radio Receiver R-390/URR	10½	17¼	19	65
1	Power Supply PP-621/URR	5¾	4¾	6¾	15
1	Power Cable Assembly CX-1358/U			96	0.677
2	Technical manuals				2
1 Set	Running spares (<i>b</i> below)				2
Total					84.677

b. Running Spares (fig. 5).

Quantity	Item
1	Electron tube, 6AJ5
1	Electron tube, 6AK6
1	Electron tube, 6BH6
2	Electron tube, 6BJ6
1	Electron tube, 6C4
1	Electron tube, 12AT7WA
2	Electron tube, 12AU7
1	Electron tube, 5651
1	Electron tube, 5749/6BA6W
2	Electron tube, 5814A
1	Electron tube, 6082
1	Electron tube 26Z5W (For PP-621/URR)
6	Fuses, cartridge, 3 amp, 125v
5	Fuse, cartridge, ¾ amp, 250v
1	Lamp, 0.04 amp, 28v
1	Resistor, current-regulating, TJ311MOI

fuses, a power cable, an if. connector, an OVENS switch, terminal boards, and special tools for use by higher echelon personnel, are mounted on the rear panel (fig. 15). Cutouts are provided to permit access to internal controls used by higher echelon personnel.

8. Additional Equipment Required

The following material is not supplied as a part of Radio Receiver R-390/URR but is required for its operation. The connectors required will depend on the particular installation.

Antenna:

Balanced Doublet or rhombic.
 Unbalanced Random-length straight-wire or whip.

Low-impedance transmission line:

Balanced 50 to 200 ohm.
 Unbalanced 70-ohm coaxial cable.
 Connector Connector Plug UG-970/U or connector Plug UG-971 U.

Headset Headset Navy type CW-49507 or

7. Description

a. The receiver (fig. 1) is designed for mounting in a standard 19-inch rack or a table-top cabinet.

b. All operating controls, indicators, and a phones jack are located on the front panel. Two handles are provided for removing the receiver from the rack or cabinet. The chassis is enclosed by dust covers which may be removed when the receiver is installed in a cabinet.

c. Antenna connectors, operating and spare

equivalent 600-ohm headset.

Mounting and housing facilities Standard 19-inch rack or cabinet such as: CY-1119/U or CY-917/URR (fixed) or CY-1216/U or CY-979/URR (mobile).

Cord Headset Cord CX-1334/U, or equivalent.

Loudspeaker LS-166/U or equivalent.

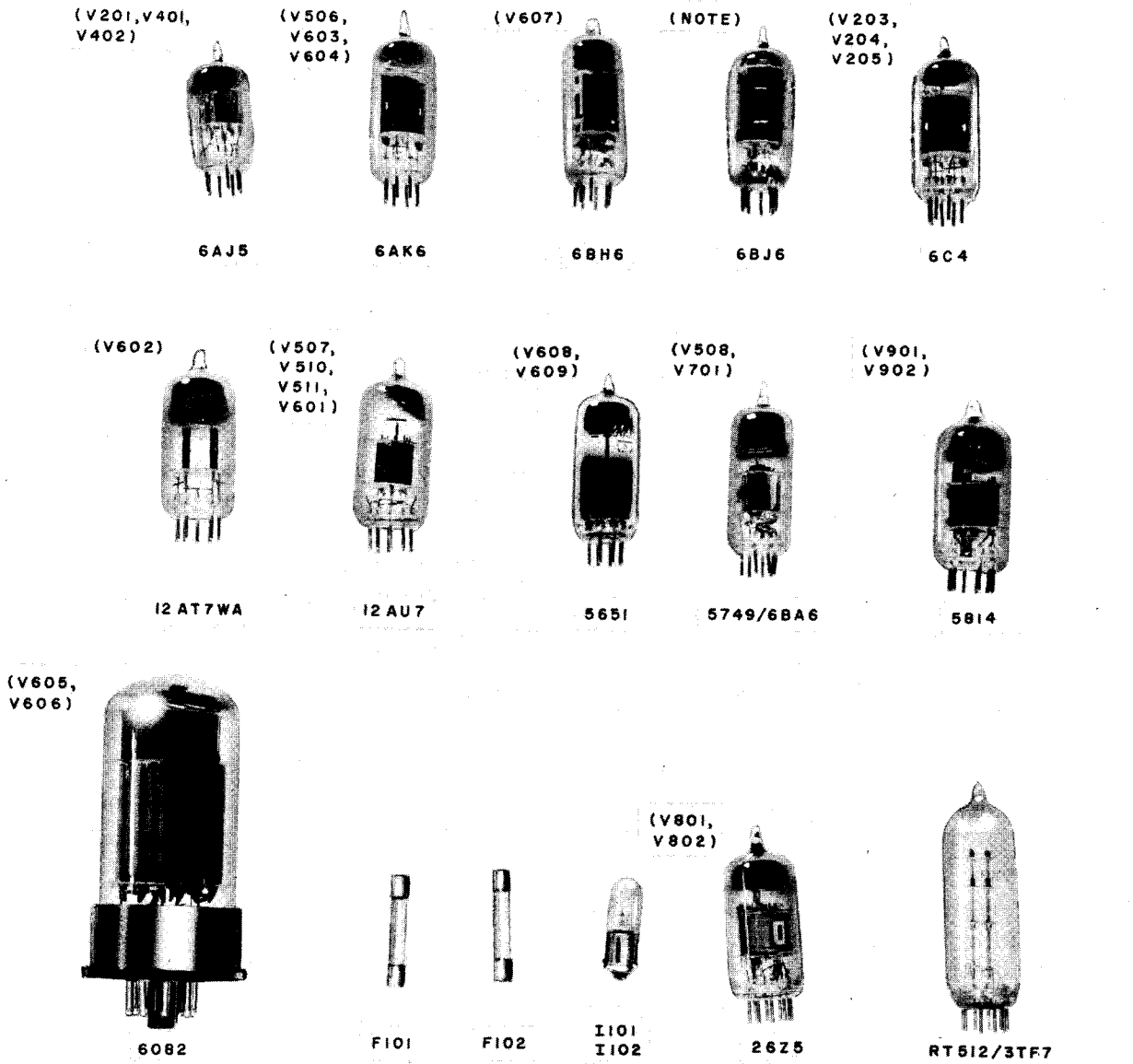

NOTE:
(V202, V501, V502, V503, V504, V505, V509)

TM 5820-357-10-5

Figure 5. Running spares.

CHAPTER 2

OPERATING INSTRUCTIONS

Note. This chapter covers only items used by the operator; items used by maintenance personnel are covered in instructions for the appropriate maintenance echelon. Installation instructions are covered in instructions for the appropriate maintenance echelon.

9. General

Take the following precautions, when setting the controls.

a. Check to see that the 115V-230V switch is in the proper position for the source of voltage being used. If this switch is placed in the 115V setting when the receiver is connected to a 230V source, the power fuses will blow and possible damage to the receiver may result.

b. Do not turn the MEGACYCLES CHANGE control beyond 00 or 31 megacycles.

c. Do not turn the KILOCYCLES

CHANGE control beyond 000 counterclockwise or 999 clockwise. If a plus or minus sign appears in the third indicator column from the left, the control has been turned too far.

d. Do not turn the FUNCTION switch counterclockwise beyond OFF or clockwise beyond SQUELCH.

10. Controls and Indicators

(fig. 6)

The receiver controls and indicators and their functions are listed in the following chart.

Control or indicator	Function										
LINE LEVEL meter	Indicates level of balanced-line output.										
LINE METER switch	<table style="width: 100%; border-collapse: collapse;"> <thead> <tr> <th style="text-align: left; width: 15%;"><i>Position</i></th> <th style="text-align: left;"><i>Function</i></th> </tr> </thead> <tbody> <tr> <td>OFF</td> <td>Disconnects LINE LEVEL METER from balanced-line output.</td> </tr> <tr> <td>+10</td> <td>Adds 10 vu to LINE LEVEL reading.</td> </tr> <tr> <td>0</td> <td>LINE LEVEL meter is read directly in vu</td> </tr> <tr> <td>-10</td> <td>10 vu is to be subtracted from the LINE LEVEL vu reading.</td> </tr> </tbody> </table>	<i>Position</i>	<i>Function</i>	OFF	Disconnects LINE LEVEL METER from balanced-line output.	+10	Adds 10 vu to LINE LEVEL reading.	0	LINE LEVEL meter is read directly in vu	-10	10 vu is to be subtracted from the LINE LEVEL vu reading.
<i>Position</i>	<i>Function</i>										
OFF	Disconnects LINE LEVEL METER from balanced-line output.										
+10	Adds 10 vu to LINE LEVEL reading.										
0	LINE LEVEL meter is read directly in vu										
-10	10 vu is to be subtracted from the LINE LEVEL vu reading.										
LINE GAIN control	Controls level of af signal supplied to balanced line output terminals.										
AGC SWITCH	A three-position switch that determines rapidity of change in gain of receiver for a certain change of signal strength.										
LIMITER switch	In any position other than OFF, is adjustable to limit static interference. Increased reduction of static interference is obtained at clockwise positions of this control.										
CARRIER LEVEL meter	Indicates level of incoming signal.										
BANDWIDTH KC control	Causes receiver to reject frequencies that differ from the carrier frequency by more than the indicated control setting.										
BFO PITCH control	Varies pitch of tone when receiving CW signals.										
AUDIO RESPONSE switch	Varies the response of the audio amplifier. <table style="width: 100%; border-collapse: collapse; margin-top: 10px;"> <thead> <tr> <th style="text-align: left; width: 15%;"><i>Position</i></th> <th style="text-align: left;"><i>Function</i></th> </tr> </thead> <tbody> <tr> <td>SHARP</td> <td>An 800-cps filter is inserted into the audio circuit and will only pass audio signals of 800 cps or less.</td> </tr> <tr> <td>MED.</td> <td>An 3,500-cps filter is inserted into the audio circuit and will only pass audio signals of 3,500 cps or less.</td> </tr> <tr> <td>WIDE</td> <td>No filters are used in this position, and the width of the received audio signal will be limited only by the type of transmission and the design characteristics of the receiver.</td> </tr> </tbody> </table>	<i>Position</i>	<i>Function</i>	SHARP	An 800-cps filter is inserted into the audio circuit and will only pass audio signals of 800 cps or less.	MED.	An 3,500-cps filter is inserted into the audio circuit and will only pass audio signals of 3,500 cps or less.	WIDE	No filters are used in this position, and the width of the received audio signal will be limited only by the type of transmission and the design characteristics of the receiver.		
<i>Position</i>	<i>Function</i>										
SHARP	An 800-cps filter is inserted into the audio circuit and will only pass audio signals of 800 cps or less.										
MED.	An 3,500-cps filter is inserted into the audio circuit and will only pass audio signals of 3,500 cps or less.										
WIDE	No filters are used in this position, and the width of the received audio signal will be limited only by the type of transmission and the design characteristics of the receiver.										

Control or indicator	Function												
FUNCTION switch	When rotated to any position other than OFF, connects receiver to power source and selects desired receiver function. The positions and functions are as follows: <table border="0" style="margin-left: 40px;"> <thead> <tr> <th style="text-align: left;"><i>Position</i></th> <th style="text-align: left;"><i>Function</i></th> </tr> </thead> <tbody> <tr> <td>STAND BY</td> <td>Receiver is disabled but the filaments remain lighted and oscillators remain on; receiver is ready for instant use.</td> </tr> <tr> <td>AGC</td> <td>Gain is controlled automatically for normal reception.</td> </tr> <tr> <td>MGC</td> <td>AGC disabled; gain is controlled manually by RF GAIN control or an external gain control.</td> </tr> <tr> <td>CAL</td> <td>Supplies CAL signals at 100-kc checkpoints.</td> </tr> <tr> <td>SQUELCH</td> <td>Squelch circuit is connected for silencing receiver when input signal falls below a level determined by setting of RF GAIN control. This enables the operator to monitor any frequency without having to listen to noise between transmissions.</td> </tr> </tbody> </table>	<i>Position</i>	<i>Function</i>	STAND BY	Receiver is disabled but the filaments remain lighted and oscillators remain on; receiver is ready for instant use.	AGC	Gain is controlled automatically for normal reception.	MGC	AGC disabled; gain is controlled manually by RF GAIN control or an external gain control.	CAL	Supplies CAL signals at 100-kc checkpoints.	SQUELCH	Squelch circuit is connected for silencing receiver when input signal falls below a level determined by setting of RF GAIN control. This enables the operator to monitor any frequency without having to listen to noise between transmissions.
<i>Position</i>	<i>Function</i>												
STAND BY	Receiver is disabled but the filaments remain lighted and oscillators remain on; receiver is ready for instant use.												
AGC	Gain is controlled automatically for normal reception.												
MGC	AGC disabled; gain is controlled manually by RF GAIN control or an external gain control.												
CAL	Supplies CAL signals at 100-kc checkpoints.												
SQUELCH	Squelch circuit is connected for silencing receiver when input signal falls below a level determined by setting of RF GAIN control. This enables the operator to monitor any frequency without having to listen to noise between transmissions.												
BREAK IN switch	In ON position, control of the receiver from a remote location is possible, and the receiver is protected from RF voltage from nearby transmitters.												
-ANT. TRIM + control	Provides means for tuning antenna circuit for maximum signal input.												
BFO switch	Places bfo in operation.												
DIAL LOCK control	Locks KILOCYCLE CHANGE control to prevent accidental change of setting.												
ZERO ADJ. control	When turned clockwise, disengages frequency indicator from KILOCYCLE CHANGE control for calibration purposes.												
LOCAL GAIN control	Controls level of af signal to headset or speaker.												
RF GAIN control	Controls gain of rf and if. amplifiers. When squelch circuit is operative, controls squelch and permits maximum agc when in the maximum clockwise position.												
MEGACYCLE CHANGE control ...	Selects any one of 32 tuning steps; change reading of first two digits of frequency indicator.												
KILOCYCLE CHANGE control	Tunes receiver to any frequency within a band and changes reading of last three digits on the frequency indicator.												
PHONES jack	Provides means of connecting a headset to the receiver.												

11. Preparing Receiver for Reception

To prepare the receiver for reception, follow the steps in figure 7.

12. Calibration Procedures

Frequency indicator calibration is required to maintain the tuning accuracy of the receiver. Calibrate the frequency indicator at the 100-kc checkpoint nearest the frequency desired for reception whenever the MEGACYCLE CHANGE control is operated to select another band. Follow the procedures given in figure 8. (For greatest accuracy and sta-

bility, the receiver should be allowed to warm up for at least 30 minutes.)

13. Reception of Voice Signals

To receive voice signals, follow the procedures given in figure 9.

14. Reception of Cw and Mcw Signals

Operate the receiver controls in the same manner as for voice reception, (fig. 9) and then follow the procedures given in figure 10.

15. Reception of Frequency-Shift Signals

Operate the receiver in the same manner as

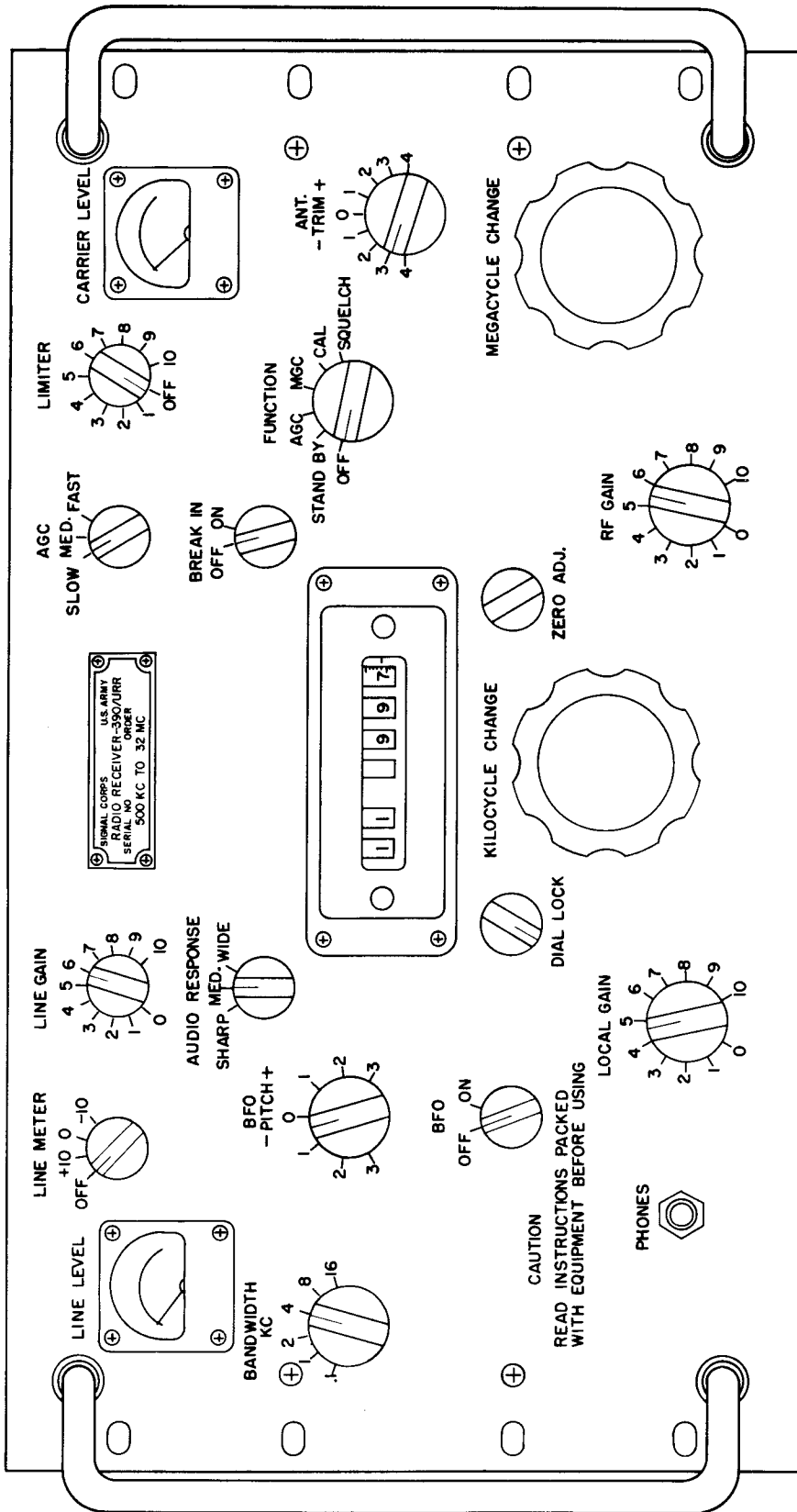

TM5820-357-10-6

Figure 6. Radio Receiver R-390/URR, front panel.

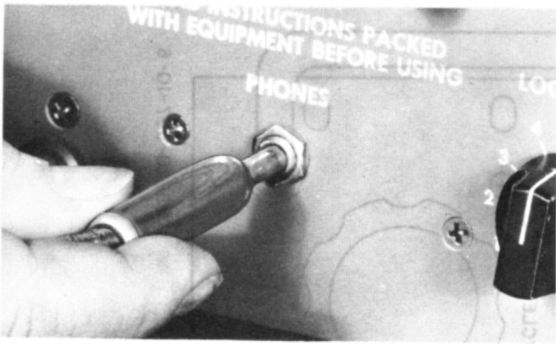

1 Plug a headset Navy Type CW-49507 or equivalent into PHONES jack on front panel.

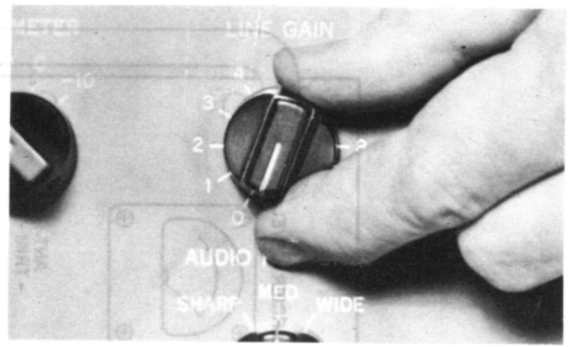

3 Turn the LINE GAIN control to 0.

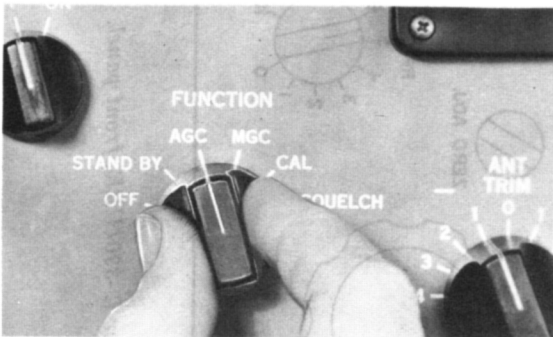

2 Turn the FUNCTION switch to AGC. Allow the receiver to warm up for several minutes before operating it.

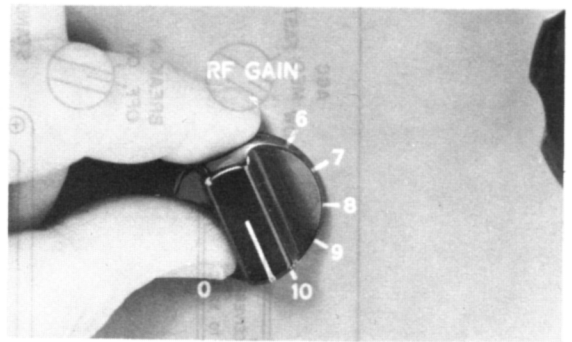

4 Turn the RF GAIN control to 10.

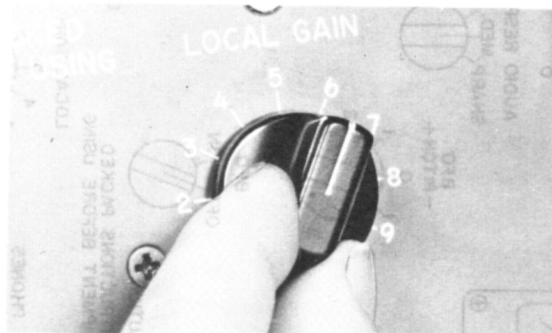

5 Turn the LOCAL GAIN control to 6.

TM5820-357-10-7①

Figure 7. Preparing receiver for reception (part 1 of 2).

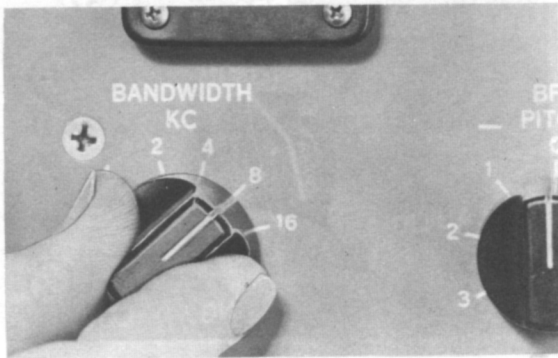

6 Turn the **BANDWIDTH** switch to 8.

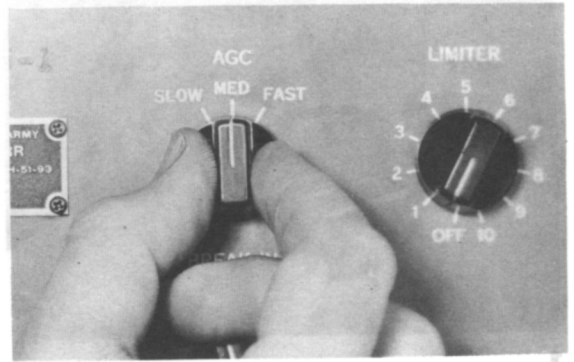

8 Turn the **AGC** switch to **MED**.

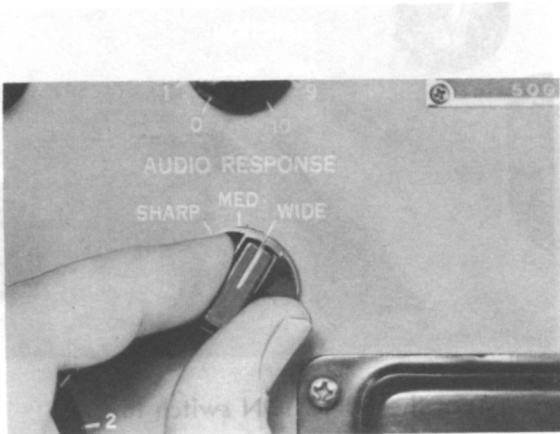

7 Turn the **AUDIO RESPONSE** switch to **WIDE**.

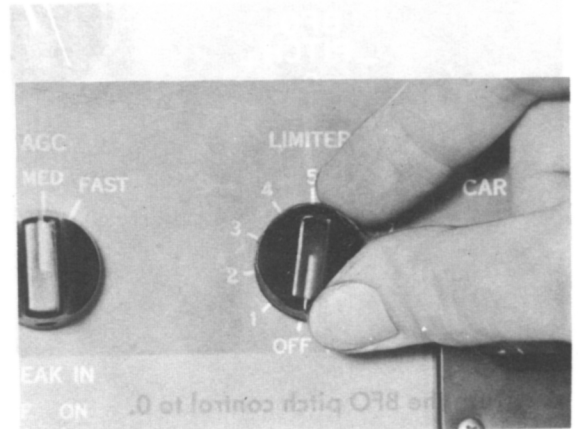

9 Turn the **LIMITER** control to **OFF**.

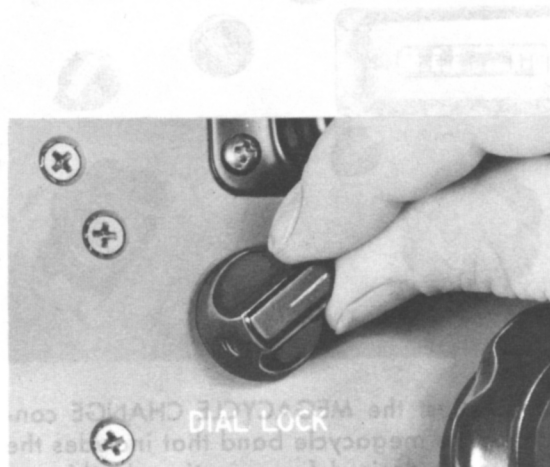

10 Turn the **DIAL LOCK** control counter-clockwise until it stops.

TM5820-357-10-7(2)

Figure 7. Preparing receiver for reception (part 2 of 2).

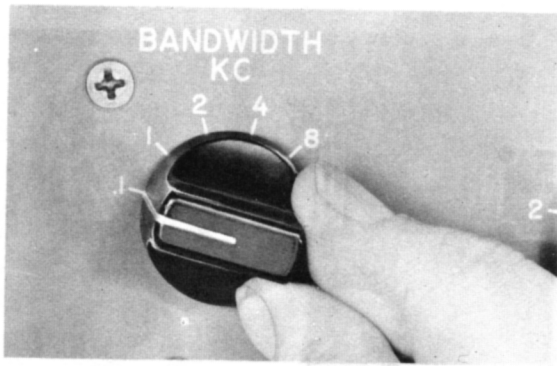

1 Set the BANDWIDTH switch to the .1 position.

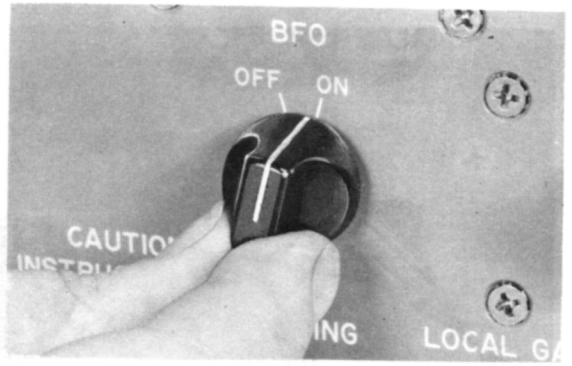

3 Turn the BFO switch to ON.

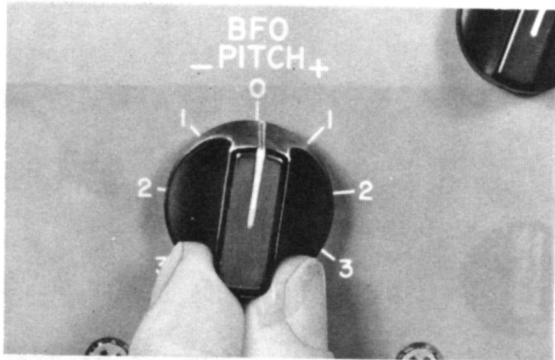

2 Turn the BFO pitch control to 0.

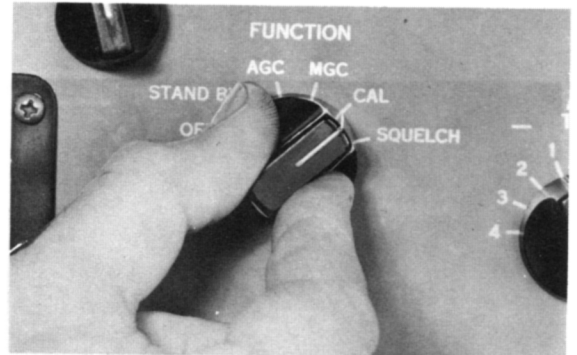

4 Turn the FUNCTION switch to CAL.

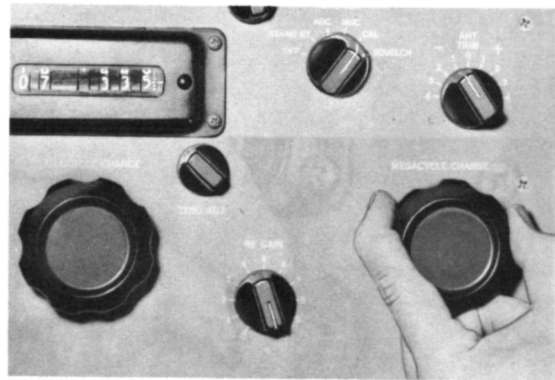

5 Adjust the MEGACYCLE CHANGE control to the megacycle band that includes the frequency desired for reception. In this example, the frequency is being set to 7335 kc; for this frequency, the nearest check point is 7300 kc.

TM5820-357-10-8(1)

Figure 8. Calibration procedure (part 1 of 2).

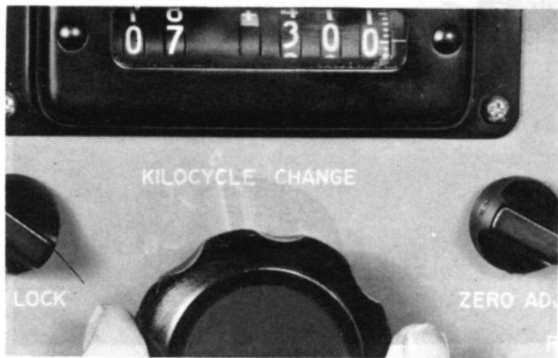

6 Adjust the KILOCYCLE CHANGE control so that the frequency indicator is at the 100-kc check point nearest the frequency desired for reception (7300 kc in this example).

Note: If a red plus or minus sign appears, do not turn the dial any further in that direction.

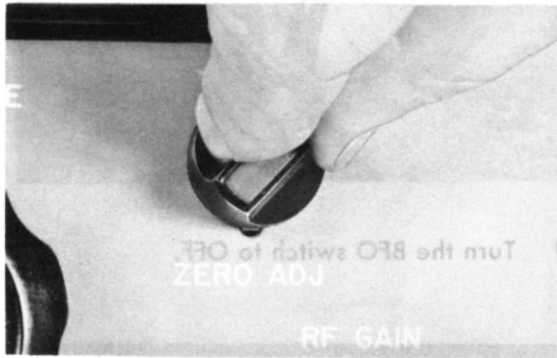

7 Turn the ZERO ADJ control fully clockwise.

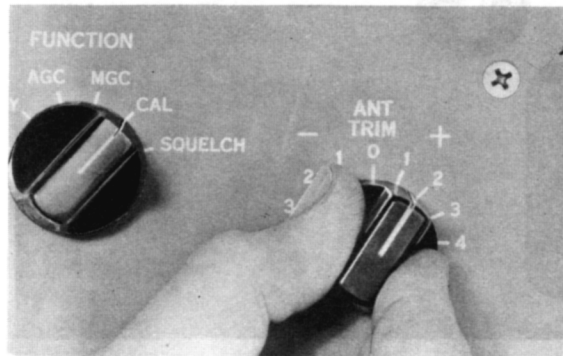

8 Rotate the ANT. TRIM control to obtain indication on CARRIER LEVEL meter.

9 Adjust the KILOCYCLE CHANGE control (see step 6) for a zero beat indication in the headset or speaker. Zero beat is indicated by a tone diminishing in pitch until it cannot be heard until the control is either turned further in the same direction or turned back towards the position it was in upon starting. The dial is now accurately calibrated.

10 Turn the ZERO ADJ control (step 7) fully counterclockwise.

TM5820-357-10-8(2)

Figure 8. Calibration procedure (part 2 of 2).

for reception of cw and mcw signals, and then follow the procedure given in figure 11. This procedure should be used for tuning the receiver to frequency-shift signals, unless another procedure is given in the technical manual covering the particular receiving system. The receiver requires exact tuning for the proper reception of frequency-shift signals. The entire procedure applies only to systems that use the audio output of the receiver, such as Radioteletypewriter Terminal Equipment AN/FGC-1. Omit the procedure given in figure 11 for equipments that use the if. output

of the receiver, such as Frequency-Shift Converter CV-116/URR.

16. Reception of Single-Sideband Signals

Operate the receiver in the same manner as for reception of cw and mcw signals, and then follow the procedure given in figure 12.

17. Stopping Procedure

If the receiver is not going to be used for a short interval (under 10 minutes), place the FUNCTION switch in STANDBY position. When the receiver is no longer needed for

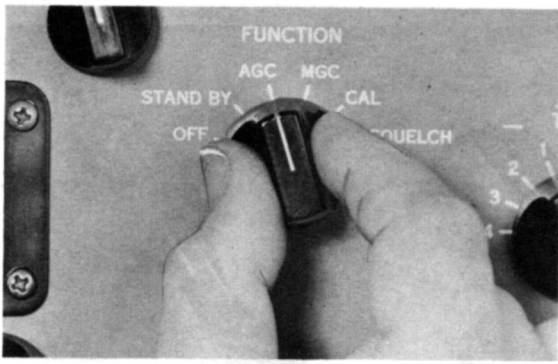

1 Turn the FUNCTION SWITCH to AGC.

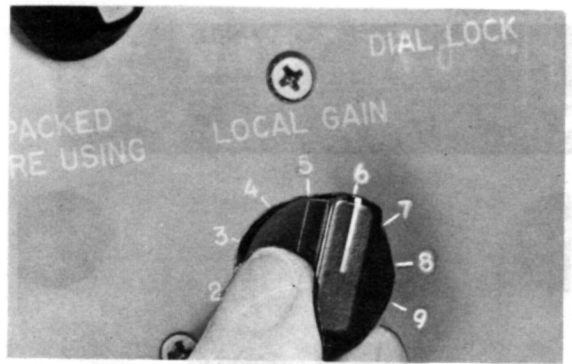

4 Turn the LOCAL GAIN control to 6.

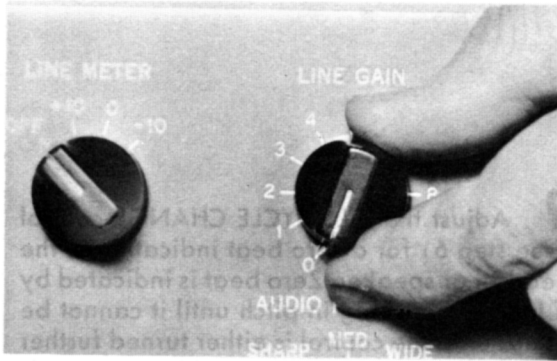

2 Turn the LINE GAIN control to 0.

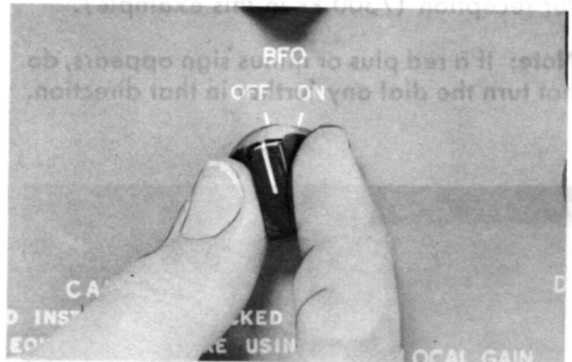

5 Turn the BFO switch to OFF.

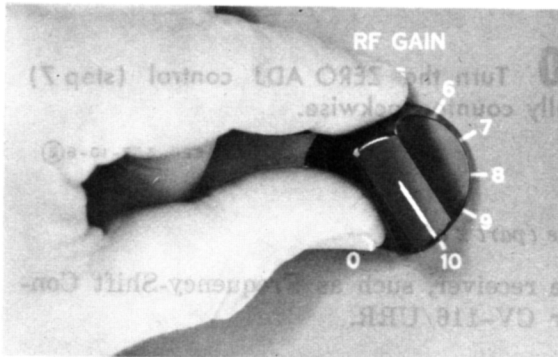

3 Turn the RF GAIN control to 10.

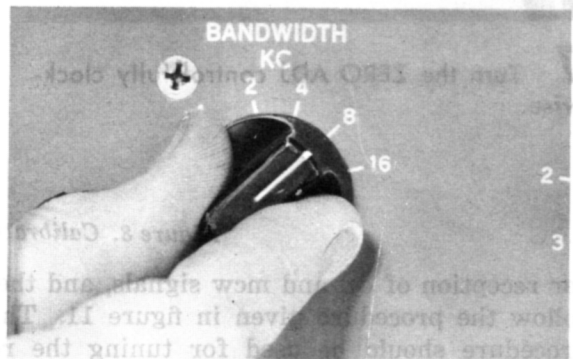

6 Set the BANDWIDTH switch to 8 kc.

TM5820-357-10-9①

Figure 9. Reception of voice signals (part 1 of 4).

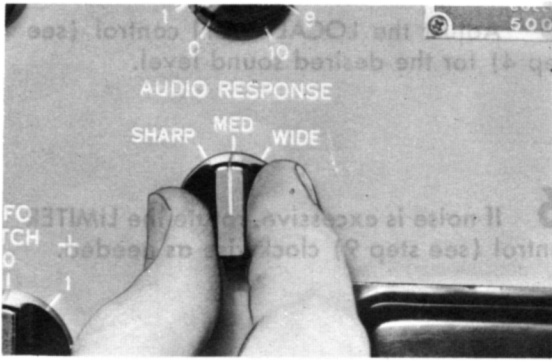

7 Turn the AUDIO RESPONSE switch to MED.

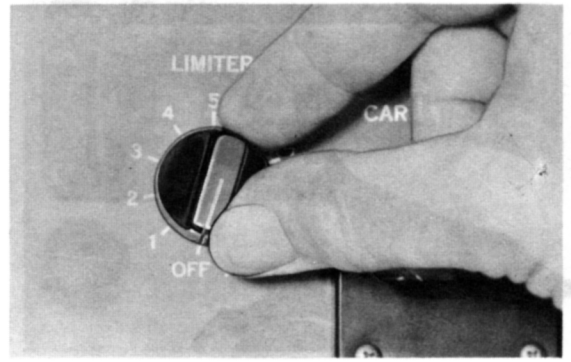

9 Turn the LIMITER control to OFF.

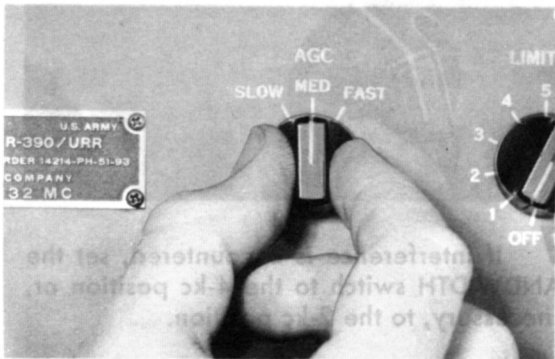

8 Turn the AGC switch to MED.



10 Disengage the DIAL LOCK control by turning fully counterclockwise.

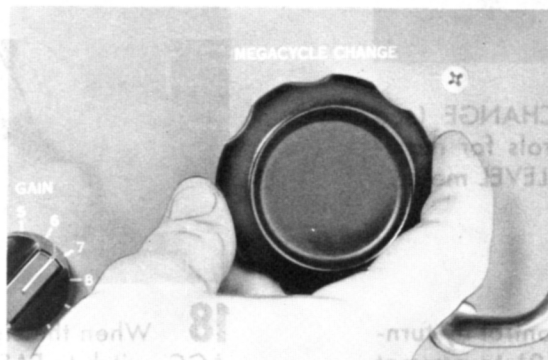

11 With the MEGACYCLE CHANGE control, select the correct band for the frequency desired.

TM 5820-357-10-9②

Figure 9. Reception of voice signals (part 2 of 4).

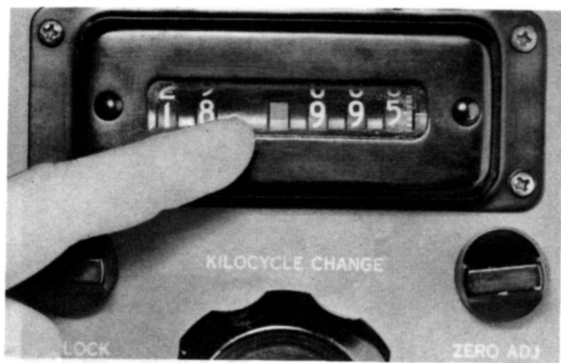

12 With the KILOCYCLE CHANGE control, set frequency reading indicator to frequency of desired station.

(To maintain tuning accuracy of at least 3 kc, calibrate the dial as directed in paragraph 13 each time the MEGACYCLE CHANGE control is operated to select another band.)

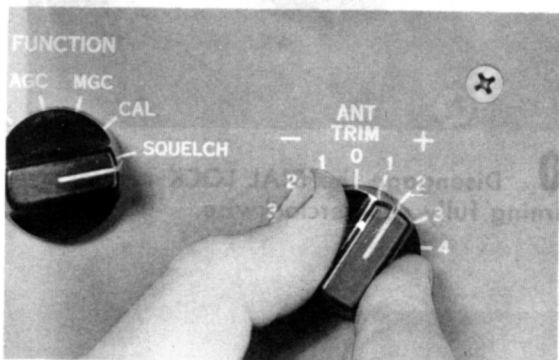

13 Adjust the KILOCYCLE CHANGE (see step 12) and ANT TRIM controls for maximum reading on the CARRIER LEVEL meter.

14 Tighten the DIAL LOCK control by turning fully clockwise (see step 10) to prevent changing of frequency setting.

15 Adjust the LOCAL GAIN control (see step 4) for the desired sound level.

16 If noise is excessive, rotate the LIMITER control (see step 9) clockwise as needed.

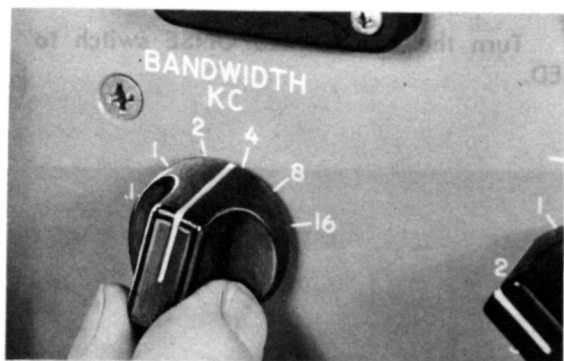

17 If interference is encountered, set the BANDWIDTH switch to the 4-kc position or, if necessary, to the 2-kc position.

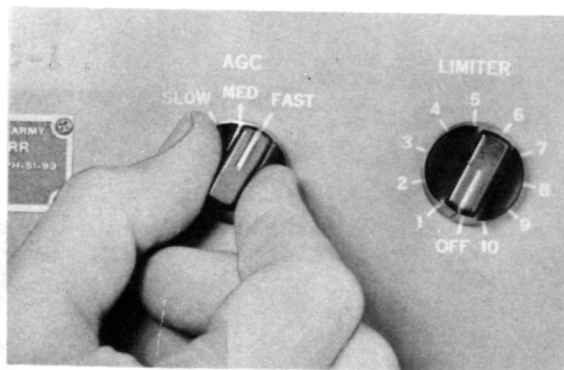

18 When the signals fade rapidly, set the AGC switch to FAST.

TM5820-357-10-9③

Figure 9. Reception of voice signals (part 3 of 4).

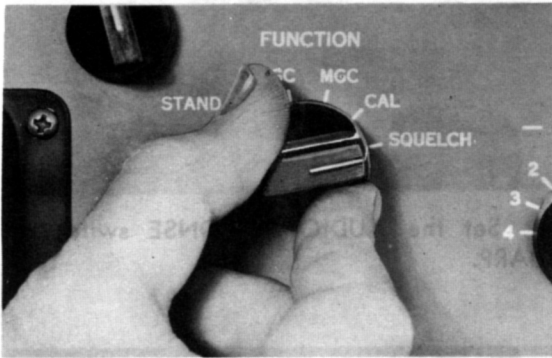

19 When it is desired to quiet the receiver between transmissions, set the FUNCTION switch to SQUELCH.

(Avoid reducing gain to such an extent that the desired signal is eliminated. Do not use squelch if the desired signals are weak and subject to fading.)

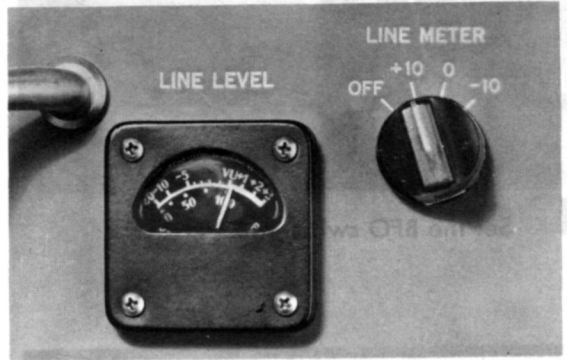

21 Adjust the LINE GAIN control (see step 2) for the desired reading on the LINE LEVEL meter, normally this reading will be 0 vu.

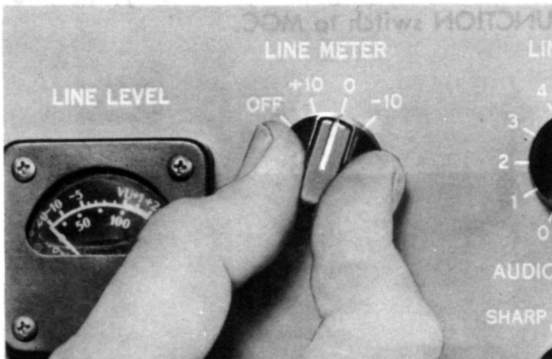

20 When the balanced-line output is being used to feed a telephone line to a remote location or to another equipment, set the LINE METER switch to the required range.

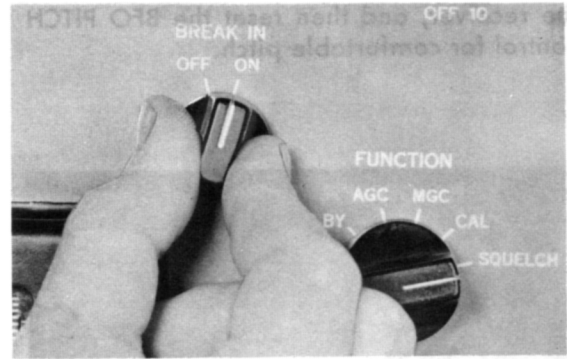

22 If the break-in relay is connected to the transmitter control circuits and the receiver is to be disabled during periods of transmission, set the BREAK-IN switch to ON.

TM5820-357-10-9④

Figure 9. Reception of voice signals (part 4 of 4).

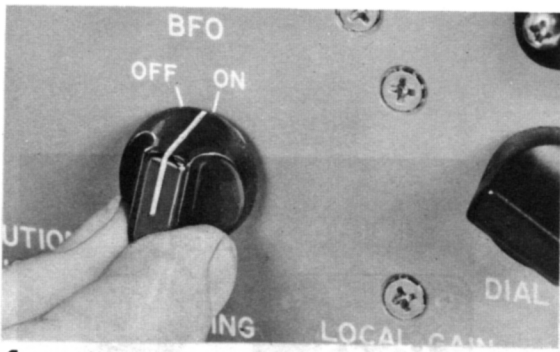

1 Set the BFO switch to ON.

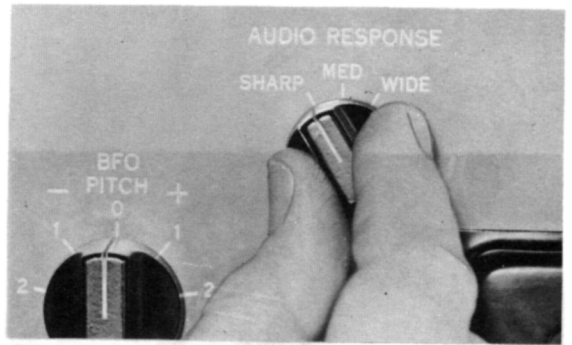

4 Set the AUDIO RESPONSE switch to SHARP.

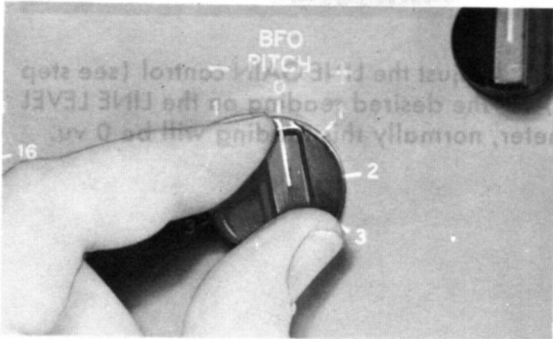

2 Set the BFO PITCH control to zero beat the receiver, and then reset the BFO PITCH control for comfortable pitch.

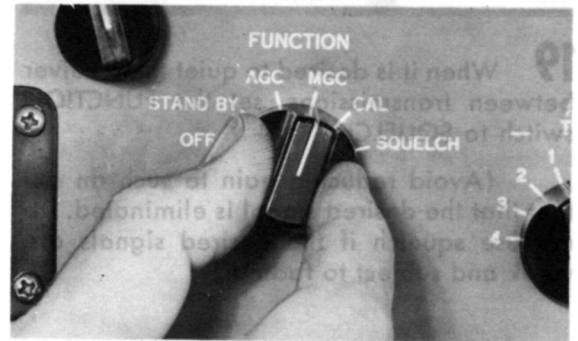

5 For manual gain control only, set the FUNCTION switch to MGC.

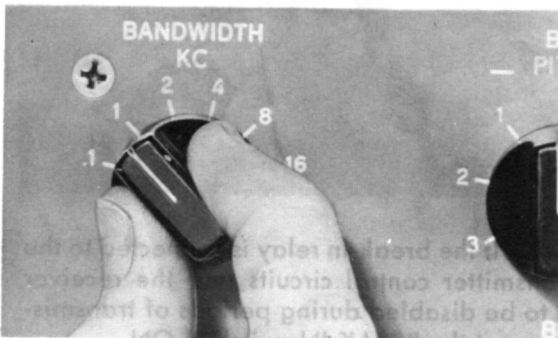

3 If interference is encountered, set the BANDWIDTH switch to the .1 kc or the 1 kc position.

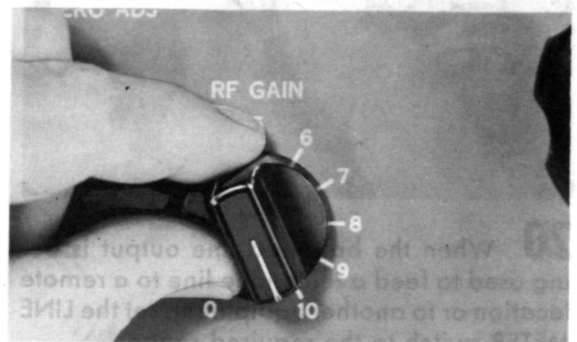

6 Control the sensitivity with the RF GAIN control; maximum sensitivity is obtained at the full clockwise position.

Note. Do not use squelch when receiving mcw signals.

TM5820-357-10-10

Figure 10. Reception of cw and mcw signals.

reception of any type signals, turn the FUNCTION switch to the OFF position. The proper stopping procedures are shown in figure 13.

18. Antijamming Procedures

When an operator recognizes that his receiver is being jammed, he will promptly inform his immediate superior officer. Under no condition will he cease operating. To provide maximum intelligibility of jammed signals, he will adhere to the operational procedure indicated for each type of operation. When receiving jammed signals, receiving conditions may be improved by performing one or more of the following procedures:

a. Rotate the KILOCYCLE CHANGES control very slowly through several dial mark-

ings on either side of the desired signal; some separation of the signal may be achieved.

b. Set the BANDWIDTH control to a lower number to give narrower bandwidth.

c. Reduce the RF GAIN.

d. For cw or mcw reception, vary the BFO PITCH control.

e. For cw reception, set the AUDIO RESPONSE switch to SHARP.

f. If severe noise is present, use the LIMITER.

g. Reset the FUNCTION switch to MGC (if AGC is being used).

Note. When receiving frequency-shift signals, refer to the technical manual covering the receiving system for antijamming procedures.

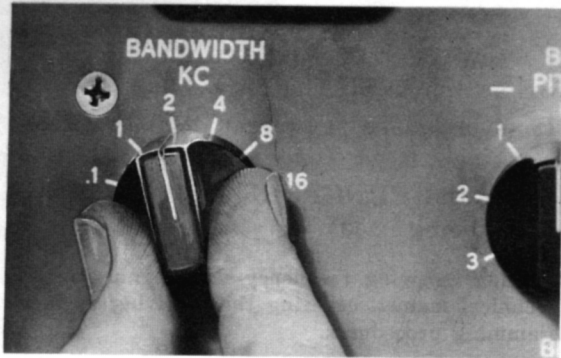

1 Turn the BANDWIDTH switch to 2.

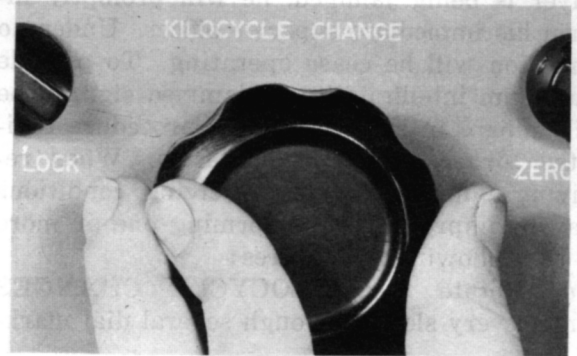

3 Tune the KILOCYCLE CHANGE control to the desired frequency; then readjust it slightly until mark and space signals with the same tone are heard.

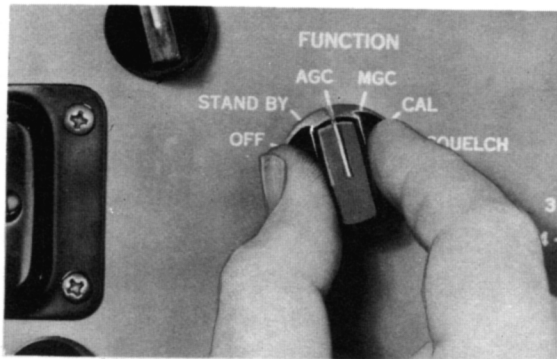

2 Turn the FUNCTION switch to AGC.

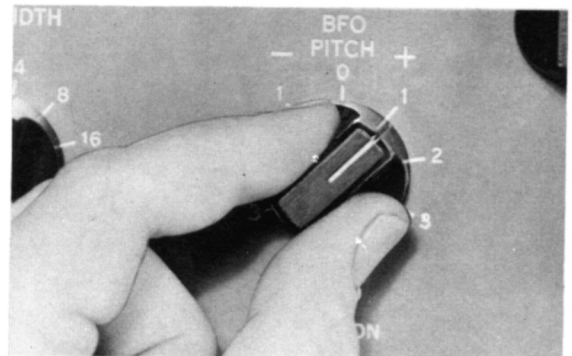

4 Adjust the BFO PITCH control until the teletypewriter prints good copy (for further information refer to manual in use for the particular system being used).

TM 5820-357-10-11 ①

Figure 11. Reception of frequency shift signals (part 1 of 2).

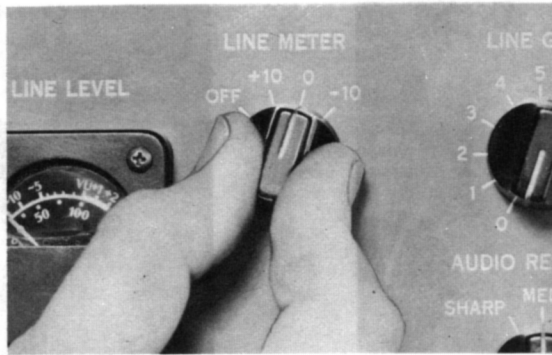

5 Turn the LINE METER switch to 0.

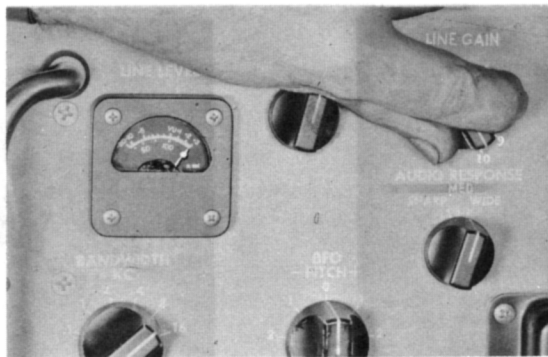

6 Turn the LINE GAIN control to 10. The LINE LEVEL meter should deflect fully to the right.

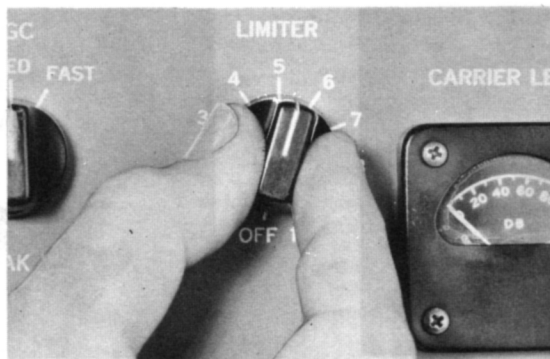

7 Adjust the LIMITER control for a LINE LEVEL meter (see step 5) indication at the VU mark.

TM5820-357-10-11(2)

Figure 11. Reception of frequency shift signals (part 2 of 2).

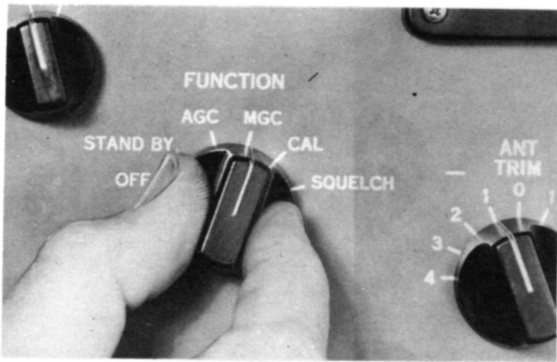

1 Set the FUNCTION switch to MGC.

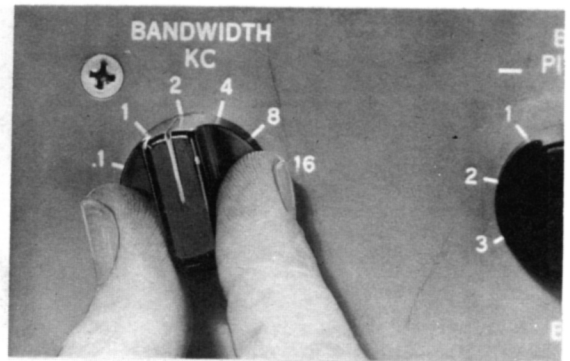

4 Set the BANDWIDTH switch to 2 kc.

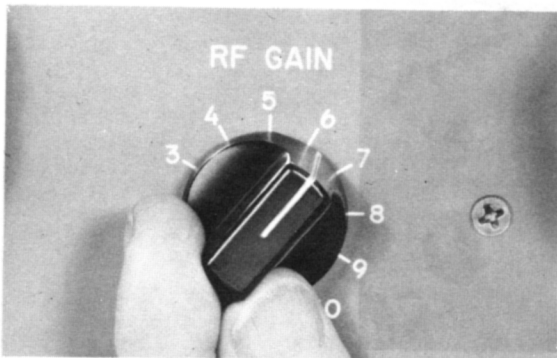

2 Set RF GAIN control to 6.

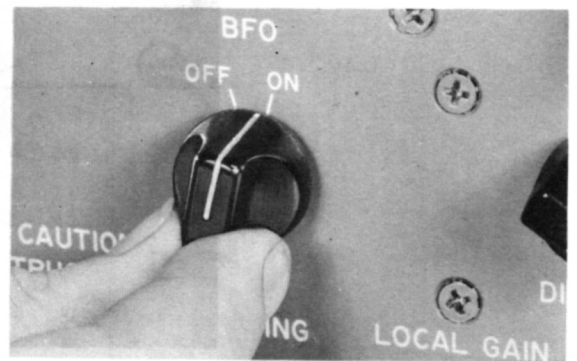

5 Turn the BFO switch to ON.



3 Set the LOCAL GAIN control between 5 and 10.

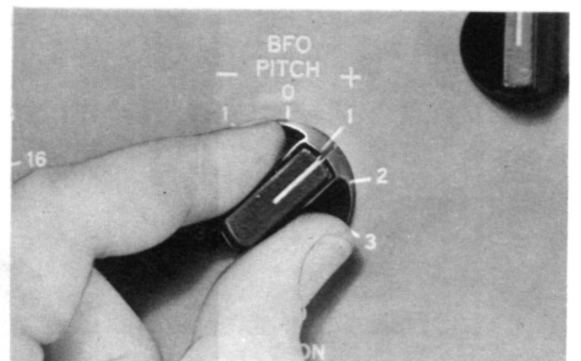

6 Set the BFO PITCH control to -1 for upper sideband reception or to +1 for lower sideband reception.

TM5820-357-10-12 ①

Figure 12. Reception of single-sideband signals (part 1 of 2).

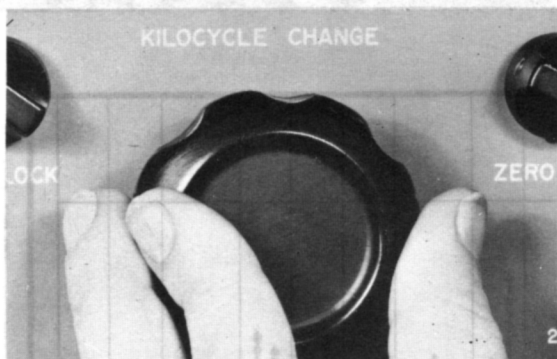

7 Tune KILOCYCLE CHANGE control to the frequency of the desired signal; +1 kc if the upper sideband is used and -1 kc if the lower sideband is used.

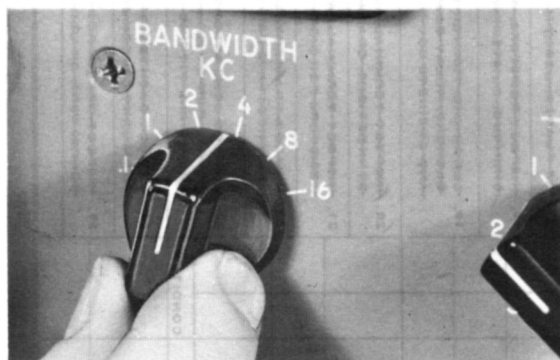

8 If a BANDWIDTH switch setting of 4 kc is to be used, for example when receiving multi-channel teletype signals, double the -1 or +1 setting (6 and 7 above) to -2 or +2.

9 Adjust the BFO PITCH (see step 6) and the KILOCYCLE CHANGE controls (see step 7) slightly for the most intelligible signal reception.

10 Adjust the LOCAL GAIN (see step 3) and the RF GAIN controls (see step 2) for the desired audio level.

M5820-357-10-12 (2)

Figure 12. Reception of single-sideband signals (part 2 of 2).

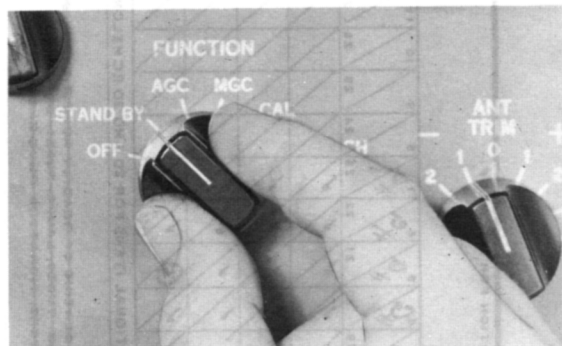

1 If receiver is to be kept in a state of readiness for instant use, set the FUNCTION switch to STAND BY. Do not leave in STAND BY position for more than 30 minutes.

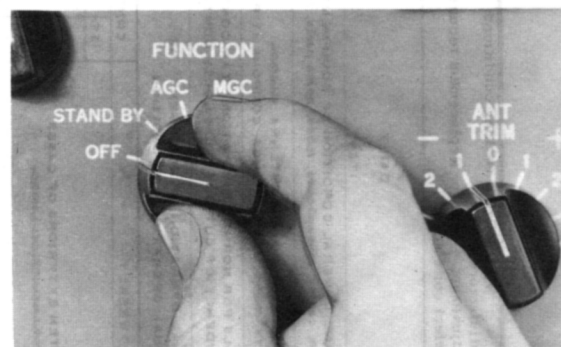

2 To turn the receiver off, turn the FUNCTION switch to OFF.

TM5820-357-10-13

Figure 13. Stopping procedure.

LEGEND for marking conditions: Satisfactory, ✓ Adjustment, Repair or Replacement required, X. Defect corrected, (X).		DAILY CONDITION FOR MONTH OF												CONDITION									
		17	18	19	20	21	22	23	24	25	26	27	28		29	30	31						
NO.	DAILY ITEM	WEEKLY					ADDITIONAL ITEMS FOR 2D AND 3D ECHELON INSPECTIONS					CONDITION											
		1ST	2D	3D	4TH	5TH	1	2	3	4	5		6	7	8	9	10	11	12	13	14	15	16
1.	COMPLETENESS AND GENERAL CONDITION OF EQUIPMENT. (Examination receiver, scanning sets, coils, microphones, tubes, spare parts, technical manuals).	✓																					
2.	CLEAN DIRT AND MOISTURE FROM ANTENNA, MICROPHONES, HEADSETS, HELMS, JACKS, COMPONENT PANELS. PARA 20b	✓																					
3.	INSPECT CONTROLS FOR NORMAL OPERATION. TAP CONTROLS LIGHTLY FOR EVIDENCE OF CUT-OUT FROM LOOSE CONTACTS. PARA 20b	✓																					
4.	CHECK FOR NORMAL OPERATION OF EQUIPMENT. BE ALERT FOR UNUSUAL OPERATION OR CONDITION. PARA 22c	✓																					
5.	CLEAN AND TIGHTEN EXTERIORS OF CASES, RACKS, MOUNTS. TRANSMISSION LINE.	✓																					
6.	INSPECT CASES, MOUNTS, ANTENNA TOWERS AND EXPOSED METAL SURFACES FOR RUST, CORROSION. PARA 20b	✓																					
7.	INSPECT CORDS, CABLE, WIRE, SHOCK MOUNTS FOR CUTS, KINKS, BREAKS, FRAVING. UNSURE PARA 21(a)(2)	X																					
8.	CHECK ANTENNA ON WIRE FOR PROPER TENSION OR DAMAGE.																						
9.	CLEAN CANVAS AND LEATHER HELMS FOR MILDEW, TEARS, FRAYING.																						
10.	INSPECT ACCESSIBLE ITEMS FOR LOOSENESS: SWITCHES, KNOBS, JACKS, CONNECTORS, RELAYS, TRANSFORMERS, MOTORS, MOTOR LIGHTS, BLOWERS, ETC.	✓																					
11.	CLEAN AND/OR INSPECT AIR FILTERS, GASKETS, NAME PLATES, DIAL AND METER WINDOWS.	✓																					
12.	INSPECT GASKETS, SWITCHES FOR DIRT, LOOSE TERMINALS, SCREWS, BRACKET, DAMAGED GASKETS. INSPECT GY SWITCHES FOR LEAKAGE.																						
ADDITIONAL ITEMS FOR 2D AND 3D ECHELON INSPECTIONS														CONDITION									
13.	INSPECT ELECTRICAL COVERS FOR ADEQUACY OF WEATHER PROOFING, TEARS, FRAYING.																						
14.	CHECK TERMINALS ON COVERS FOR BRACKETS, DIRT, LEAKS, DAMAGED GASKETS, GASKETS.																						
15.	INSPECT SEATING OF RELAYS IN RECEIVING SOCKET FOR WIRE TUBES, LEAKS, RUBBER SHEETING, CONNECTIONS, WORN CONTACTS, PLUGS IN SOCKETS.																						
16.	INSPECT RELAYS AND CIRCUIT BREAKERS FOR LOOSE MOUNTINGS AND CONTACTS, MISALIGNMENT OF CONTACTS AND SPRINGS, PROPER SPRING TENSION.																						
17.	INSPECT VARIABLE CAPACITORS FOR DIRT, MISALIGNMENT OF PLATES, LOOSE MOUNTING, INSULATION.																						
18.	INSPECT RESISTORS, SWITCHES AND INDUCTORS FOR SPRINGS, CHIPPING, DETERIORATION, MEASUREMENT, DISCOLORATION.																						
19.	CLEAN AND TIGHTEN SWITCHES, TERMINAL BLOCKS, SLOWERS, RELAY CASES AND INTERLOCKS OF CHASSIS AND COMPONENTS NOT REACHY ACCESSIBLE.																						
20.	INSPECT TERMINAL BLOCKS FOR LOOSE CONNECTIONS, SNAGS AND BREAKS.																						
21.	INSPECT TERMINALS OF LARGE FIXED CAPACITORS AND RESISTORS FOR DIRT, CORROSION, LOOSE CONTACTS.																						
22.	INSPECT TRANSFORMERS, CHOICES, POTENTIOMETERS AND RESISTORS FOR OVERHEATING AND OIL LEAKAGE.																						
23.	INSPECT GENERATORS, AMPLIFIERS, DYNAMOS FOR BRUSH WEAR, SPRING TENSION, WRENCH AND PARTS OF COMMUTATOR.																						
24.	INSPECT BATTERIES AND TUBES FOR SUDDEN GREEN SPOTS.																						
25.	INSPECT WATERPROOF OF GASKETS FOR TEARS, WORN OR LOOSE PARTS.																						

CONTINUED ON PAGE 4

Figure 11 - A Form 11-238.

CHAPTER 3

MAINTENANCE INSTRUCTIONS

19. Scope of Operator's Maintenance

The following is a list of maintenance duties normally performed by the operator of Radio Receiver R-390/URR. These procedures do not require special tools or test equipment.

- a. Preventive maintenance (para 20).
- b. Visual inspection (para 21).
- c. Operational checklist (para 23).
- d. Replacement of defective fuses.
- e. Receiver calibration (para 12).

20. Preventive Maintenance

a. *DA Form 11-238.* DA Form 11-238 (fig. 14) is a preventive maintenance checklist to be used by the operator. Items not applicable to the receiver are lined out. References in the ITEM block in the figures are to paragraphs that contain additional maintenance information pertinent to the particular item. Instructions for the use of the form appear on the form.

b. *Items.* The information shown in this subparagraph is supplementary to DA Form 11-238. The item numbers correspond to the ITEM numbers on the form.

Item	Maintenance procedures
2	Use a clean cloth to remove dust, dirt, moisture, and grease from the antenna, mast base, microphone, headset, and front panel controls. If necessary, wet the cloth with Cleaning Compound (Federal stock No. 7930-395-9542) and then wipe the parts with a clean dry cloth.
3	All control knobs should work smoothly, be tight on the shaft, and should not bind. Tighten all loose knobs and be sure that the knobs do not rub against the panel.

Warning: Cleaning compound is flammable and its fumes are toxic. Do not use near a flame; provide adequate ventilation.

21. Visual Inspection

a. When the equipment fails to perform

properly, turn the power off and check for the following conditions:

- (1) Wrong setting of switches and controls.
- (2) Headset cord or power cord disconnected.
- (3) Antenna lead-in wire disconnected or antenna broken or grounded.
- (4) Burned-out fuse. (para 22).

b. If the above checks do not locate the trouble, proceed to the operational checklist (para 23).

22. Checking Fuses

Equipment failure is frequently caused by a blown fuse. Spare fuses (2-, and 3-, and $\frac{3}{8}$ -ampere) are mounted on the rear panel under a protective cover.

Caution: Turn off power when replacing fuses. Fuses of correct values must be used or serious damage to the receiver may result. If the replacement fuse burns out immediately after insertion, do not put another fuse in until the cause of fuse failure has been determined by higher echelon repair.

23. Operational Checklist

a. *General.* The operational checklist will help the operator to locate the trouble quickly. The corrective measures are used to repair this trouble. If the suggested measures do not restore normal equipment performance, troubleshooting is required by a field radio mechanic. Note on the repair tag what corrective measures were taken and how the equipment performed at the time of failure.

b. *Procedure.* Place the set in operation (para 11). After the equipment has had time to warm up, perform the steps given in c below (in the order given). Observe the equipment operation and perform any corrective measures necessary.

c. Checklist.

Action	Normal indication	Corrective measure
FUNCTION switch at AGC.....	Dial lamps light..... Rushing noise or signal heard in headset.	Check power cable and fuses. Check headset cord and plug.
Turn MEGACYCLE CHANGE.....	Proper numbers appear in frequency-indicator window.	Higher echelon repair required.
Turn KILOCYCLE CHANGE control to a desired station.	Desired station is heard.....	Higher echelon repair required.
Adjust ANT TRIM control for a maximum indication of CARRIER LEVEL meter.	A maximum deflection of meter is obtained.	Higher echelon repair required.
Turn BFO switch to ON.....		Higher echelon repair required.
Turn KILOCYCLE CHANGE control.....	A whistle-like tone is heard as each station is tuned in.	Higher echelon repair required.
Turn BFO PITCH control.....	The pitch of the tone changes.....	Higher echelon repair required.
Turn FUNCTION switch to STAND BY.	No noise or signal is heard; dial lamp remains lighted.	Higher echelon repair required.
Turn FUNCTION switch to OFF.....	Dial lamps go out.....	Higher echelon repair required.

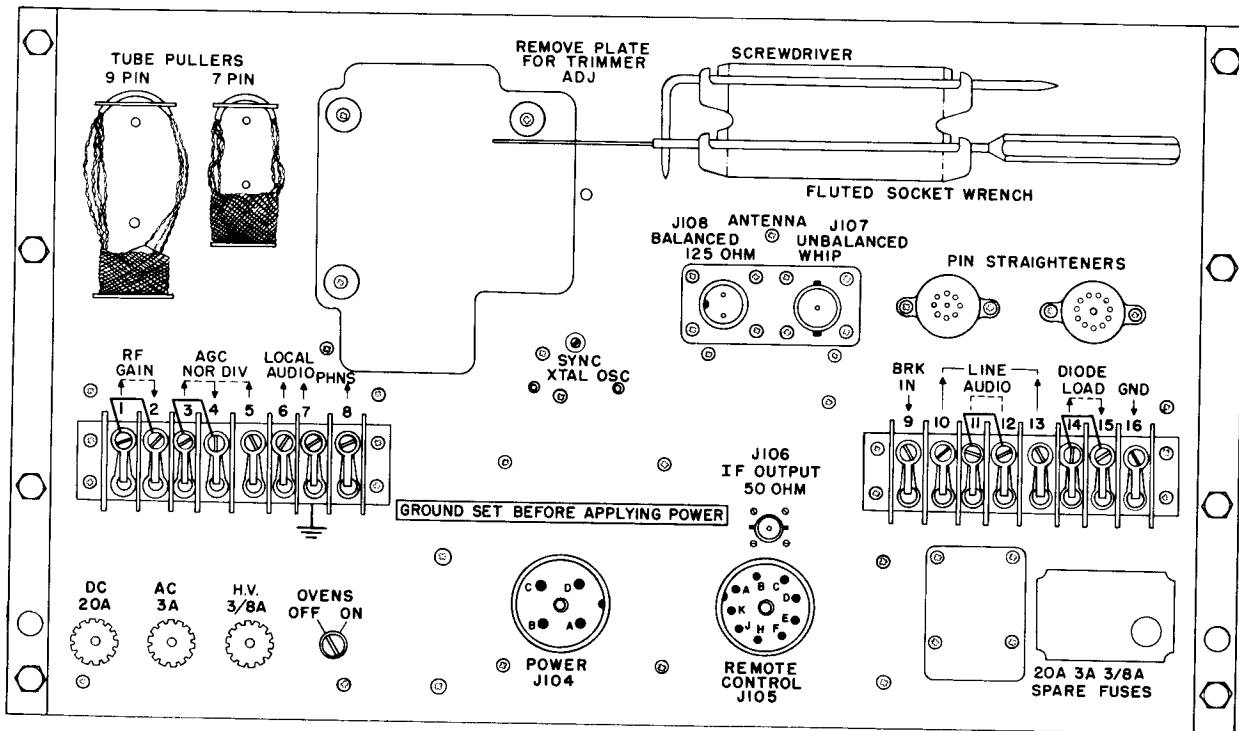

Figure 15. Radio Receiver R-390/URR, back panel.

TM5820-357-10-15

CHAPTER 4

DEMOLITION OF MATERIEL TO PREVENT ENEMY USE

24. Authority for Demolition

Demolition of the equipment will be accomplished only upon the order of the commander. The destruction procedure outlined in paragraph 25 will be used to prevent further use of the equipment.

25. Methods of Destruction

Use any or all of the methods of destruction given below. The time available will be the major determining factor for the methods used. The tactical situation also will determine in what manner the destruction order will be carried out.

a. Smash. Smash tuning indicator, dials, meter, and controls; use sledges, axes, hammers, crowbars, and any other heavy tools available to smash the interior of the set. Use the heaviest tool on hand if time does not permit removing the set from the case.

b. Cut. Cut all cords, cables, and wiring in a number of places; use axes, machetes, and similar tools. If time permits, slash the interior wiring and cabling.

c. Burn. Burn as much of the equipment as is flammable; use gasoline, oil, flamethrowers, or similar tools. Burn instruction literature first. Pour gasoline on the cut cables and internal wiring and ignite it. Use a flamethrower if available to burn the spare parts or pour gasoline on the spares and ignite it. Use incendiary grenades to complete the destruction of the equipment interiors.

d. Explode. Use explosives to complete the demolition or to cause maximum destruction when time does not permit complete demolition by other means; use powder charges, fragmentation grenades or incendiary grenades. Incendiary grenades usually are most effective if destruction of small parts and wiring is desired.

e. Dispose. Bury or scatter destroyed parts in slit trenches, foxholes, or throw them into streams.

Warning: Make sure that all power is disconnected before attempting any of the above methods of destruction. Be extremely careful with explosives and incendiary devices. Use these items only when the need is urgent.

APPENDIX I

REFERENCES

Following is a list of references applicable and available to the operator of Radio Receiver R-390/URR.

DA PAM 108-1	Index of Army Motion Pictures, Film Strips, Slides and Photo Recordings.	SR 320-5	Dictionary of United States Army Terms.
DA PAM 310-4	Index of Technical Manuals, Technical Bulletins, Supply Bulletins, Lubrications Orders, and Modification Work Orders.	SR 320-50	Authorized Abbreviations and Brevity Codes.
FM 21-5	Military Training.	TM 11-649	Radio Receiving Sets AN/FRR-40 and AN/FRR-41.
FM 21-6	Techniques of Military Instruction.	TM 11-5820-357-20P	Organizational Maintenance Repair Parts and Special Tools Lists and Maintenance Allocation Chart: Receiver, Radio R-390/URR.
FM 21-30	Military Symbols.	TM 11-5820-359-12P	Operator and Organizational Maintenance Repair Parts and Special Tools Lists and Maintenance Allocation Chart: Power Supply PP-621/URR.

APPENDIX II

BASIC ISSUE ITEMS LIST

Section I. INTRODUCTION

1. Scope

a. This appendix lists items supplied for initial operation and for running spares. The list includes tools, accessories, parts, and material issue as *part of* the major end item. The list includes all items authorized for basic operator maintenance of the equipment. End items of equipment are issued on the basis of allowances prescribed in equipment authorization tables and other documents that are a basis for requisitioning.

b. Columns are as follows:

- (1) *Source, maintenance, and recoverability code.* Not used.
- (2) *Federal stock number.* This column lists the 11-digit Federal stock number.
- (3) *Designation by model.* Not used.
- (4) *Description.* Nomenclature or the standard item name and brief identifying data for each item are listed in this column. When requisitioning, enter the nomenclature and description on the requisition.
- (5) *Unit of issue.* The unit of issue is the

supply term by which the individual item is counted for procurement, storage, requisitioning, allowances, and issue purposes.

- (6) *Expendability.* Expendable items are indicated by the letter X; nonexpendable items are indicated by NX.
- (7) *Quantity authorized.* Under "Items Comprising an Operable Equipment", the column lists the quantity of items supplied for the initial operation of the equipment. Under "Running Spares and Accessory Items," the quantities listed are those issued initially with the equipment as spare parts. The quantities are authorized to be kept on hand by the operator for maintenance of the equipment.
- (8) *Illustrations.* Not used.

2. Critical Items

A zero slash (ϕ) in the "Description" column indicates items that are expected to fail during the first year or items that will make the equipment inoperative if they fail.

Section II. FUNCTIONAL PARTS LIST

(1) SOURCE MAINTENANCE AND RECOVERABILITY CODE	(2) FEDERAL STOCK NUMBER	(3) DESIGNATION BY MODEL	(4) DESCRIPTION	(5) UNIT OF ISSUE	(6) EXPENDABILITY	(7) QUANTITY AUTHORIZED	(8) ILLUSTRATIONS	
							FIGURE NO	ITEM NO
			ITEMS COMPRISING AN OPERABLE EQUIPMENT					
	5820-503-1242		RECEIVER, RADIO R-390/URR	ea	XX			
	Order thru AGC		TECHNICAL MANUAL TM 11-5820-357-10	ea	X	2		
	5995-173-8839		CABLE ASSEMBLY, POWER CX-1358/U; 2 cond No. 18 AWG; 8 ft 1q	ea	X	1		
	5820-539-9006		POWER SUPPLY PP-621/URR: (Installed in end eqpt)	ea	XX	1		
			RUNNING SPARES AND ACCESSORY ITEMS					
			RECEIVER, RADIO R-390/URR					
	5960-188-3553		Ø ELECTRON TUBE: MIL type 6AJ5	ea	X	1		
	5960-188-3551		Ø ELECTRON TUBE: MIL type 6AK6	ea	X	1		
	5960-188-3602		Ø ELECTRON TUBE: MIL type 68B16	ea	X	1		
	5960-188-6589		Ø ELECTRON TUBE: MIL type 68J6	ea	X	2		
	5960-188-8515		Ø ELECTRON TUBE: MIL type 6C4	ea	X	1		
	5960-262-0167		Ø ELECTRON TUBE: MIL type 12AT7WA	ea	X	1		
	5960-166-7663		Ø ELECTRON TUBE: MIL type 12AU7	ea	X	2		
	5960-167-0389		Ø ELECTRON TUBE: MIL type 5651	ea	X	1		
	5960-264-2089		Ø ELECTRON TUBE: MIL type 5749/68AV6; (when V701 is replaced sub-assembly must be adjusted)	ea	X	1		
	5960-262-0210		Ø ELECTRON TUBE: MIL type 581A1; (when changing tubes, V901 and V902 should be changed at same time)	ea	X	1		
	5960-264-1486		Ø ELECTRON TUBE: type 6002 per BUSHIPS Spec	ea	X	1		
	5920-131-9821		Ø FUSE, CARTRIDGE: 3 amp; 125V; Littlefuse No. 313003	ea	X	6		
	5920-537-6647		Ø FUSE, CARTRIDGE: 3/8 amp; 250v; MIL type F02GR375B	ea	X	5		
	6240-155-7836		Ø LAMP, INCANDESCENT: 28v; 0.04 amp; Fed Spec No. W-L-111b, trade No. 327	ea	X	1		
	5905-502-4840		Ø RESISTOR, CURRENT REGULATING: MIL type TJ311V01	ea	X	1		

By Order of *Wilber M. Brucker*, Secretary of the Army:

G. H. DECKER,
General, United States Army,
Chief of Staff.

Official:

R. V. LEE,
Major General, United States Army,
The Adjutant General.

Distribution:

Active Army:

To be distributed in accordance with DA Form 12-7 requirements for TM 11 Series (Uncl) plus the following formula:

USASA (2)	11-57
CNGB (1)	11-85
Tech Stf, DA (1) except	11-86
CSigO (18)	11-98
DASA (5)	11-117
US ARADCOM (2)	11-155
US ARADCOM Rgn (2)	11-500 (AA-AE) (4)
MDW (1)	11-557
Seventh US Army (2)	11-587
EUSA (2)	11-592
Units org under fol TOE (2 cy ea	11-597
except as indc):	32-51
11-7	32-56
11-16	32-57
11-32	

NG: State AG (3); Units—Same as Active Army except allowance is one copy to each unit.

USAR: None.

For explanation of abbreviations used, see AR 320-50.

Last Page